

PROLUMIA®

LED PRODISC II + LED PRODISC II MINI
+ LED PRODISC II MAXI



GEBRUIKSAANWIJZING OPERATING INSTRUCTION

4000944x	Prodisc II Mini
4000945x	Prodisc II Mini + Microwave sensor
4000940x	Prodisc II
4000941x	Prodisc II + Microwave sensor
4000946x	Prodisc II Maxi
4000947x	Prodisc II Maxi + Microwave sensor

CE IP44  

ATTENTIE

ATTENTION

Lees de volgende instructies zorgvuldig door om ervoor te zorgen dat de montagewerkzaamheden op de juiste manier worden uitgevoerd. Bewaar deze instructies goed voor eventueel toekomstig gebruik.

Please read the following instructions carefully to ensure that mounting operation will be carried out correctly. These instructions should be properly preserved for future reference.

OPGELET

CAUTION

1. Het product dient te worden geïnstalleerd door gekwalificeerde personen. De installatie dient, voorafgaand aan de montage, spanningsloos te worden gemaakt. (The product must be installed by qualified technicians. The power supply must be cut before installation.)
2. De installatiedraad moet minimaal $2 \times 0,75 \text{mm}^2$ zijn en worden aangesloten in overeenstemming met de laatste elektriciteitsvoorschriften van IEE of volgens de nationale eisen. (The installation wiring must be $2 \times 0.75 \text{mm}^2$ at least and wired in accordance with the latest IEE electrical regulations or the national requirements.)
3. Raak het elektronische circuit en de componenten niet aan. (Do not touch the electronic circuit and its components.)
4. Raak de LED's niet aan tijdens installatie of onderhoud. (Do not touch the LEDs while installing or maintaining.)
5. De LED lichtbron van de lamp kan niet worden vervangen. Het volledige product dient te worden vervangen als de lichtbron defect is. (The LED light source of the lamp cannot be replaced. The complete product must be replaced if the light source is broken.)

TECHNISCHE DATA

TECHNICAL DATA

Voedingsspanning (Supply voltage): 220-240V 50/60Hz

Lichtbron (Light source): LED SMD2835

Bedrijfstemperatuur (Operating temperature): -20°C - +50°C

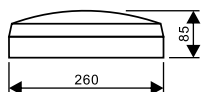

LED Prodisc II Mini

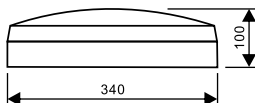

LED Prodisc II

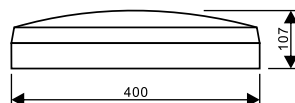

LED Prodisc II Maxi

TECHNISCHE INFORMATIE

TECHNICAL INFORMATION

Artikelnr. (Article no.)	Spanning (Voltage)	LED type	Vermogen (Power)	Lichtstroom (Light output)	MW sensor
4000944x	220-240V 50/60Hz	SMD2835	9W	840Lm - 900Lm	Nee (No)
4000945x	220-240V 50/60Hz	SMD2835	10W	840Lm - 900Lm	Ja (Yes)
4000940x	220-240V 50/60Hz	SMD2835	15W	1400Lm - 1500Lm	Nee (No)
4000941x	220-240V 50/60Hz	SMD2835	16W	1400Lm - 1500Lm	Ja (Yes)
4000946x	220-240V 50/60Hz	SMD2835	30W	2800Lm - 3000Lm	Nee (No)
4000947x	220-240V 50/60Hz	SMD2835	31W	2800Lm - 3000Lm	Ja (Yes)

MONTAGE

MOUNTING

1. Draai de afscherming los en open het LED paneel. (Disassemble the diffuser and LED panel.)
2. Haal het aansluitsnoer door de thule en fixeer met de trekontlasting. (Pull the power cord through the gasket.)
3. Bevestig het armatuur d.m.v. schroeven op de ondergrond. (Fix the fixture on the surface with screws.)
4. Sluit het aansluitsnoer correct aan op de terminal. (Connect the power cord on the terminal correctly.)
5. Sluit het LED paneel en bevestig de afscherming. (Assemble the LED panel and diffuser.)

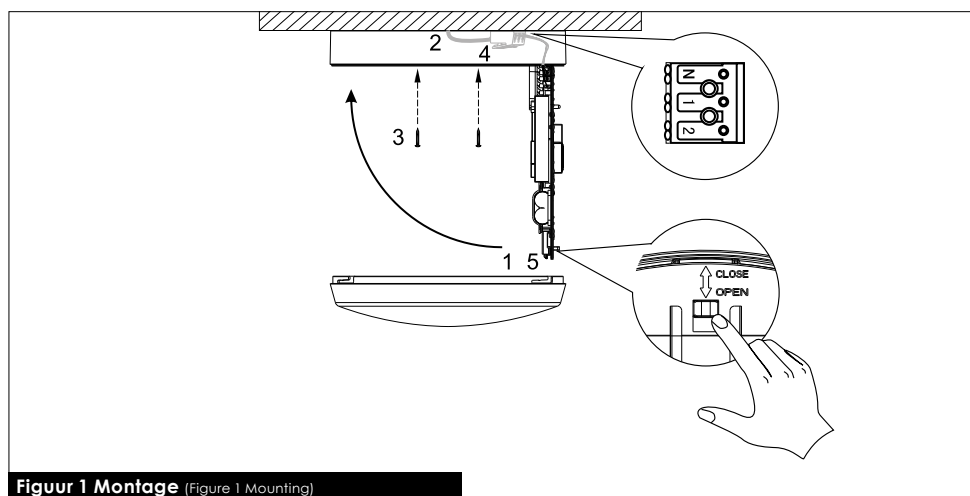

Figuur 1 Montage (Figure 1 Mounting)

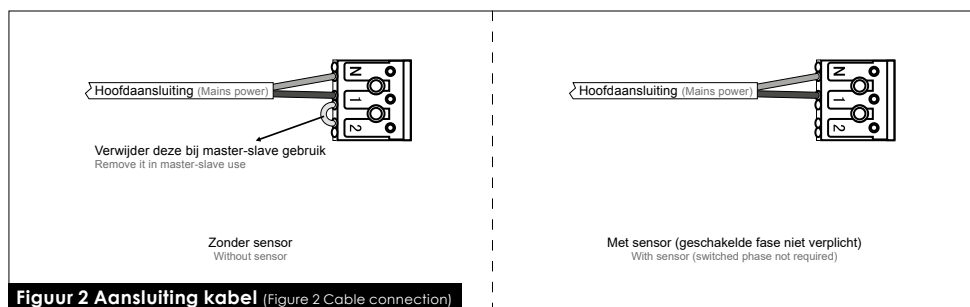

Figuur 2 Aansluiting kabel (Figure 2 Cable connection)

BESCHRIJVING VAN DE MW SENSOR

DESCRIPTION OF THE MICROWAVE SENSOR

- Detectiebereik max. (D x H): 14m x 6m
Detection zone max. (d x h): 14m x 6m
- Detectie-gevoeligheid: 25% - 100%, instelbaar
Detection sensitivity: 25% - 100%, adjustable
- Brandduur: 5sec - 30min, instelbaar
Hold time: 5sec - 30min, adjustable
- Daglicht 1: 5 - 15Lux, instelbaar of uitschakelen
Daylight 1: 5 - 15Lux, adjustable or disable
- Daglicht 2: 35 - 150Lux, instelbaar of uitschakelen (bij daglichtprioriteit)
Daylight 2: 35 - 150Lux, adjustable or disable (with daylight priority)
- Nalooptijd: 5 - 30sec - 1 - 5 - 15 - 30min (instelbaar)
Hold time: 5 - 30sec - 1 - 5 - 15 - 30min (adjustable)
- Nalooptijd oriëntatieverlichting: 0 - 10 - 20 - 30 - 60 - ∞ min (instelbaar)
Hold time orientation lighting: 0 - 10 - 20 - 30 - 60 - ∞ min (adjustable)
- Montagehoogte: 6m max.
Mounting height: 6m max.
- Bewegingsdetectie: 0,5 ~ 3m/s
Motion detection: 0.5 ~ 3m/s
- Detectiehoek: 150° (wandmontage), 360° (plafondmontage)
Detection angle: 150° (wall installation), 360° (ceiling installation)

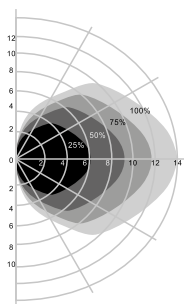

Patroon wandmontage (Eenheid: m)
Voorgestelde montagehoogte: 1 - 1,8m

Wall mounting pattern (Unit: m)
Suggested installation height: 1 - 1.8m

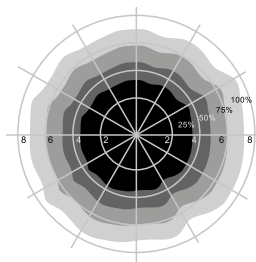

Patroon wandmontage (Eenheid: m)
Voorgestelde montagehoogte: 2,5 - 6m

Ceiling mounting pattern (Unit: m)
Suggested installation height: 2.5 - 6m

INSTELLING PARAMETERS VAN MW SENSOR

MICROWAVE SENSOR PARAMETER SETTINGS

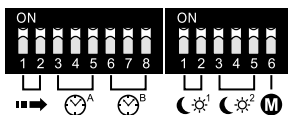

Defectiebereik (Detection area)

Dit bepaalt het effectieve bereik van de bewegingsmelder en wordt met de micro-schakelaars op de sensor ingesteld, zie figuur onder. Wees er van bewust dat het verminderen van de gevoeligheid ook het detectiebereik zal verkleinen. (This determines the effective range of the motion detector and is set with DIP switches on the sensor, please see figure below. Note that reducing the sensitivity will also narrow the detection range.)

	1	2	
I	ON	ON	100%
II	—	ON	75%
III	ON	—	50%
IV	—	—	25%

Nalooptijd (Hold time)

Dit bepaalt de tijd dat het armatuur op 100% niveau blijft branden. Dit kan worden ingesteld met micro-schakelaars op de sensor, zie figuur onder. Tijdens het installeren van het armatuur is de looptest-instelling handig om de juiste werking en het bereik vast te stellen. (This determines the time the fixture remains at 100% and is set with DIP switches on the sensor, please see figure below. The walk test setting is useful when installing the fixture to establish correct operation and range.)

	3	4	5	
I	ON	ON	ON	5s
II	—	ON	ON	30s
III	ON	—	ON	1min
IV	—	—	ON	5min
V	ON	ON	—	15min
VI	—	—	—	30min

Nalooptijd oriëntatieverlichting (Hold time orientation lighting)

Gedurende deze periode zal het armatuur op laag niveau (20%) branden. Wanneer deze is ingesteld op +∞ geeft het armatuur permanent 20% licht als er geen beweging gedetecteerd wordt. Dit wordt ingesteld met micro-schakelaars op de sensor, zie figuur onder. (During this period, the fixture will light up at low level (20%). When this is set to +∞, the fixture gives permanent 20% light when no movement detected. It is set with DIP switches on the sensor, please see figure below.)

	6	7	8	
I	ON	ON	ON	0s
II	—	ON	ON	10min
III	ON	—	ON	20min
IV	—	—	ON	30min
V	ON	ON	—	60min
VI	—	—	—	+∞

Daglicht 1 (Daylight 1)

Hiermee kan de sensor het armatuur inschakelen wanneer het omgevingslicht volledig daglicht (15Lux), weinig daglicht (10Lux) of donker (5Lux) is. Ook kan de sensor hiermee worden uitgeschakeld. Dit wordt ingesteld met micro-schakelaars op de sensor, zie figuur onder. Zolang het lichtniveau boven de ingestelde waarde ligt, zal het armatuur bij bewegingsdetectie uitblijven. (This allows the sensor to switch the unit on when daylight level is either full daylight (15Lux), low daylight (10Lux), or after dark (5Lux). It also allows the sensor to be disabled. As long as the light level is above the set point, the fixture will stay off when motion is detected.)

	1	2	
I	ON	ON	Disable
II	—	ON	15Lux
III	ON	—	10Lux
IV	—	—	5Lux

INSTELLING PARAMETERS VAN MW SENSOR

MICROWAVE SENSOR PARAMETER SETTINGS

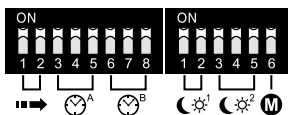

Daglicht 2 (Daylight 2)

Dit is alleen van toepassing onder modus 2. Het verwijst naar het daglichtniveau waaronder het armatuur op laag niveau gaat branden. (This is only applicable under mode 2. Under this daylight level the fixture will light at low level.)

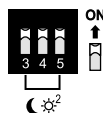

	3	4	5	
I	ON	ON	ON	Disable
II	—	ON	ON	150Lux
III	ON	—	ON	100Lux
IV	—	—	ON	75Lux
V	ON	—	—	50Lux
VI	—	—	—	35Lux

Modus (Mode)

Modus 1: Armatuur blijft uit bij bewegingsdetectie indien het daglichtniveau boven de bij "Daglicht 1" ingestelde waarde ligt. (Mode 1: Fixture remains off during motion if the daylight level is above the value set at "Daylight 1".)

Modus 2: Indien het daglichtniveau onder de bij "Daglicht 2" ingestelde waarde komt, zal het armatuur op laag niveau gaan branden. Bij bewegingsdetectie wordt opgeschakeld naar 100%. (Mode 2: When the daylight level falls below the value set under "Daylight 2", the fixture will light at low level. When motion is detected, it is shifting to 100%.)

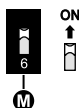

	6	
I	ON	Mode 1
II	—	Mode 2

INSTELLING PARAMETERS VAN MW SENSOR

MICROWAVE SENSOR PARAMETER SETTINGS

A 0% / 100% / 20%



M Modus (Mode)

ON ↑

	6	
I	ON	Mode 1
II	—	Mode 2

M

⌚^B Nalooptijd (Hold time)

ON ↑

	6	7	8	
I	ON	ON	ON	0s
II	—	ON	ON	10min
III	ON	—	ON	20min
IV	—	—	ON	30min
V	ON	ON	—	60min
VI	—	—	—	+∞

⌚^B

B 0% / 100%



M Modus (Mode)

ON ↑

	6	
I	ON	Mode 1
II	—	Mode 2

M

⌚^B Nalooptijd (Hold time)

ON ↑

	6	7	8	
I	ON	ON	ON	0s
II	—	ON	ON	10min
III	ON	—	ON	20min
IV	—	—	ON	30min
V	ON	ON	—	60min
VI	—	—	—	+∞

⌚^B

INSTELLING PARAMETERS VAN MW SENSOR

MICROWAVE SENSOR PARAMETER SETTINGS

C 20% / 100%

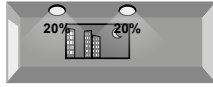
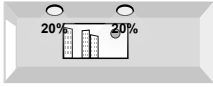

M Modus (Mode)

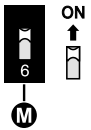

	6	
I	ON	Mode 1
II	—	Mode 2



^B Nalooptijd (Hold time)



	6	7	8	
I	ON	ON	ON	0s
II	—	ON	ON	10min
III	ON	—	ON	20min
IV	—	—	ON	30min
V	ON	ON	—	60min
VI	—	—	—	+∞



D 0% / 20% op basis van daglicht (based upon daylight) / 100% bij beweging (when triggered)

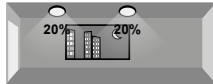
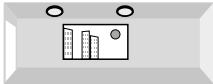

M Modus (Mode)

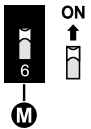

	6	
I	ON	Mode 1
II	—	Mode 2



^B Nalooptijd (Hold time)



	6	7	8	
I	ON	ON	ON	0s
II	—	ON	ON	10min
III	ON	—	ON	20min
IV	—	—	ON	30min
V	ON	ON	—	60min
VI	—	—	—	+∞



MASTER/SLAVE FUNCTIE

MASTER/SLAVE FUNCTION

Functie A (Function A)

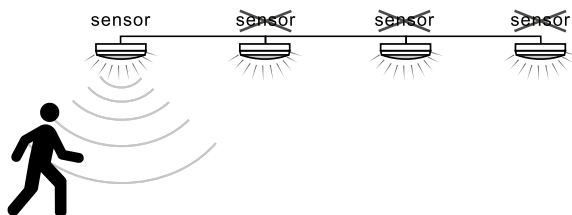

Functie B (Function B)

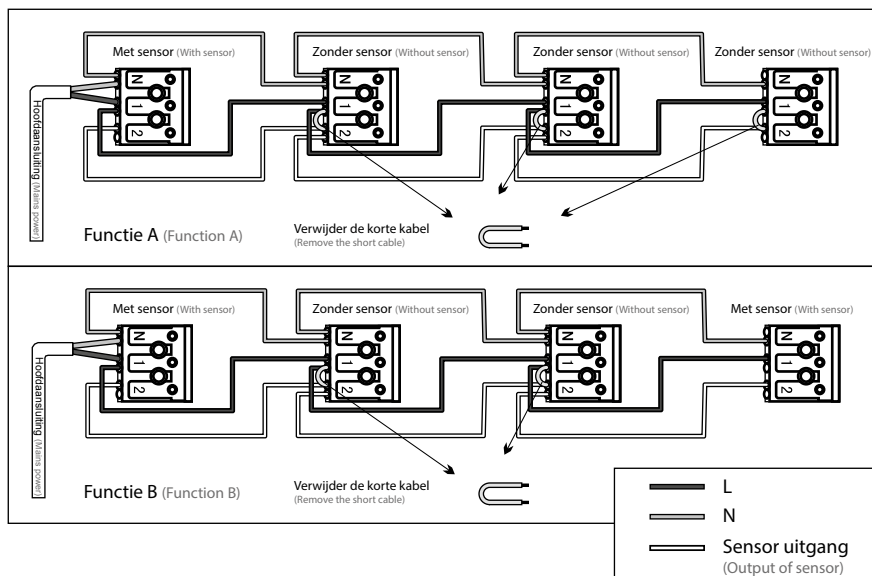
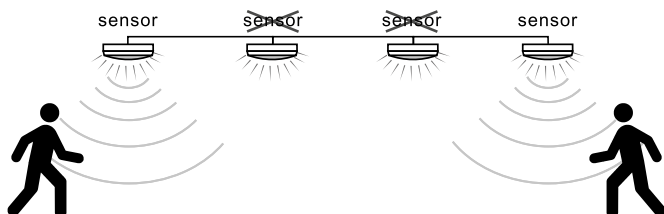

ONDERHOUD

MAINTENANCE

1. Maak het armatuur spanningsloos. (Cut off the mains power first.)
2. Raak de LED's niet aan tijdens onderhoud of schoonmaak. (Don't touch the LEDs while maintaining or cleaning.)
3. Gebruik geen chemische schoonmaakmiddelen om de lamp te reinigen. (Don't use chemical reagent to clean lamp.)

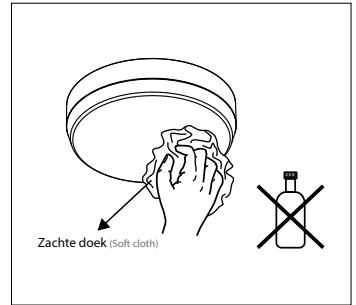
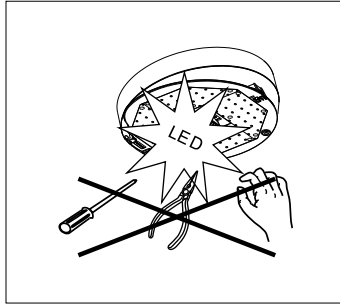
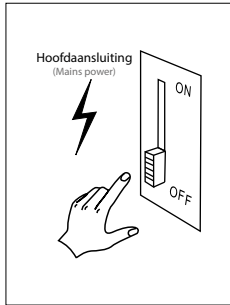

BESCHERMING VAN HET MILIEU

ENVIRONMENTAL PROTECTION



Defecte elektrische apparaten behoren niet te worden weggegooid bij het huishoudelijk afval. Recycle waar mogelijk. Neem contact op met uw gemeente of uw leverancier voor een deskundig recycling advies. (Waste electrical products should not be disposed of with household waste. Please recycle where facilities exist. Check with your local authority or retailer for recycling advice.)

PROLUMIA®

IMPORTEUR

IMPORTER

NEDELKO B.V.

Riga 10

2993 LW BARENDRECHT

T +31 (0)180 64 54 00

F +31 (0)180 64 54 05

E info@nedelko.nl

NEDELKO BELGIUM NV

Prins Boudewijnlaan 49

2650 EDEGEM

T +32 (0)3 826 99 99

F +32 (0)3 826 99 90

E info@nedelko.be

NEDELKO s.r.o.

Purkyňova 74/2

110 00 PRAHA 1 - NOVÉ MĚSTO

T +420 222 563 003

F +420 222 563 004

E info@nedelko.cz